

SONAC® 220

DATA SHEET
Motion & Position
Bulk Level



FUNCTION

Single Point Switch for on-off control of bulk solids.
On-off switch presence/absence, indication of objects.

TYPICAL USES

HighLevel Alarm or Control	Web Break Detection
Plugged Chute Detection	Truck and R.R. Position
Conveyor Control	LowLevel Alarm or Control
Flow/No Flow Detection	

PRIMARY AREAS OF APPLICATION

Where material to be sensed constantly changes physical properties, eg: Municipal Solid Waste. Reliable sensing does not depend on any specific physical or electrical characteristics of the material.

Low bulk density materials

Eg: Textile fibers, onion skins, popcorn, styrofoam pellets, puffed cereals. This sensing technique permits sensing products which are so light that they cannot be reliably sensed by other means. Reliably senses products with bulk densities of less than 1/4 lb./cubic foot.

Stringy, fibrous materials

Eg: Yarn, chipped fibers, waste paper, trash. Sensor is mounted flush with bin wall to prevent material build-up at sensing point. No moving parts to catch fibers.

Delicate materials

Eg: Puffed cereals, potato chips. Nothing projects into falling product to crush it, no motion of sensor to fracture fragile products.

Abrasive materials

Eg: Crushed coal, sand, ore. Rugged construction. No moving parts. Hermetically sealed sensors do not protrude into flow stream.

Hot materials

Series 14 sensors are designed for continuous operation at 400°F (+205°C).

Small hoppers

Nothing protrudes into hopper to obstruct flow.

FEATURES

- Vibration resistant
The rugged magnetostrictive sensors are designed to tolerate sustained shock and vibration. The control unit is designed for remote mounting away from the vibrating equipment.
- Independent time delays
Delay on make or delay on break contact adjustments are non-interacting and independent.
- Corrosion resistant, watertight enclosure
Glass-reinforced polyester enclosure features captive hardware and stainless steel trim to endure the most corrosive environments.
- Versatile power supply
The standard units accepts 115 Volts AC, 230 Volts AC or low voltage 24 DC input power.
- Self-Test
The Sonac 220 is equipped with a self test circuit. Pressing the momentary switch located on the far right of the board will activate it. An optional external switch is also available.



DELANAN

Process Instrumentation

PRINCIPLE OF OPERATION

A pair of matched sensors is connected to an amplifier as a receiver (microphone) and a transmitter (loudspeaker). When the amplifier gain is increased to the point where its gain exceeds the loss in the acoustic path between the sensors, oscillation (feedback) occurs. An object entering the acoustic path increases the loss and the oscillation decreases.

In the Sonac[®] system, one sensor is connected to the Sonac[®] amplifier and operates essentially as a loudspeaker. This transmitting sensor will produce ultrasonic sound waves of the frequency dictated by the sensors themselves. The other sensor which we will call the receiving sensor is connected to the amplifier as a microphone and will deliver to the amplifier electrical energy from ultrasonic sounds reaching its diaphragm. The amplifier itself is capable of amplifying the weak sounds received by the receiving sensor more than 1,000,000 times.

The Sonac[®] sensors are, by design, quite directional in their response to sound waves. If the transmitting and receiving sensors are positioned facing each other and the path between the two sensors is unobstructed and the electrical gain in the amplifier is sufficient to overcome the losses in sound energy across the path between the two sensors, acoustic feedback will occur. This, of course, cannot be heard, as Sonac[®] is designed to operate near 38,000 Hz. This is well above the range of human hearing.

When the acoustic characteristics of the air path are changed by variations in temperature, relative humidity, or standing wave conditions, then the Sonac[®] system merely adjusts itself to some new frequency which is optimum for the present path conditions. In every case the actual frequency of the acoustic feedback in the Sonac[®] path is whatever frequency will produce the least loss across the path. In actual operation, this change in frequency is limited by the electrical characteristics of the amplifier and the acoustic properties of the sensors.

SPECIFICATIONS

Input Voltage	NOMINAL	ABSOLUTE LIMITS
	115 Volts AC	95-135 Volts AC
	230 Volts AC	180-270 Volts AC
	24 Volts DC	21-28 Volts
Power	4VA volt amperes	
Frequency, AC Power	50-60 Hz	
Time Delay	Independent with Auto Reset on make, on break	
Delay Time Range	50 milliseconds min.	
	10 seconds nominal	
	30 seconds max.	
Fail-Safe	Switch selectable - High Level or Low Level	
	High Level Fail-safe Position: Relay is de-energized when material is present	
Indicators	Low Level Fail-safe Position: Relay is de-energized when material is not present	
	Two, light emitting diodes (LED) YELLOW - illuminated when relay is energized RED - illuminated when material is present at sensor	
Operating Temperature	-40°F to +160°F (-40°C to +71°C)	
Output	Relay, 2 Form C contacts DPDT	
Ratings	5 amp @ 120 Volts AC Non-inductive	
	3 amp @ 240 Volts AC Non-inductive	
	3 amp @ 24 Volts DC Non-inductive	
Maximum Cable Length	PVC - 50 feet (15.24M)	
	Teflon - 30 feet (9.14M)	
Shipping Weight	Control Unit - 5 pounds (2.25 kilograms)	
	Sensor - 1.5 pounds (0.68 kilograms)	
	Cable - 0.5 pounds (0.45 kilogram)	

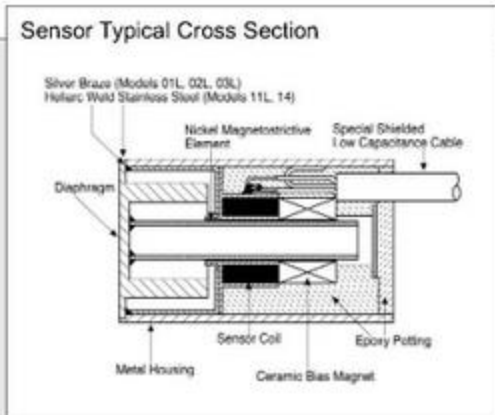
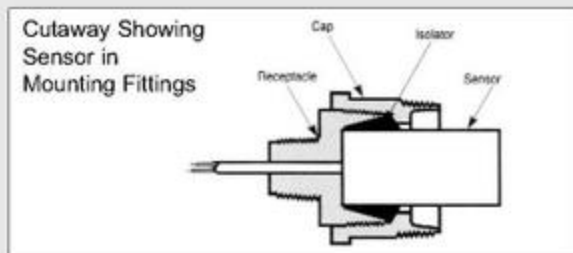
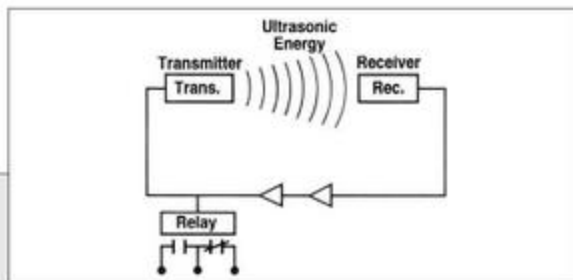

Sensors
Transmitters and Receivers
Sensors are supplied as matched pairs

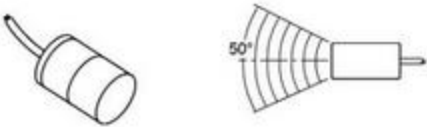
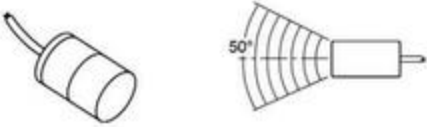
Model No.	Transmitting Angle	Description	Typical Applications
Corrosion Resistant Sensor Face - 316 Stainless Steel		50 ft. PVC cable standard. 10 ft. max. sound path. Temp. range from -65°F to +220°F (-54°C to +104°C) Minimum Distance - 2 inches* Maximum Distance - 12 feet* *depending on process material Keep at least 18 inches (457.2 mm) between adjacent sensors.	Bin Level Control Food Products Corrosive Products
11L			
High Temperature Sensor Face - 316 Stainless Steel		Sensor temperature range -65°F to +400°F (-54°C to +205°C). 15 ft. Teflon cables are standard. For high temperature applications use Part #31308-3 fitting. Minimum Distance - 2 inches* Maximum Distance - 12 feet* *depending on process material Keep at least 18 inches (457.2 mm) between adjacent sensors	Dry Level Control Webb Break
14			

Bin-Wall Fittings

P/N	Temperature Limit	Material	Mounting Thread	Conduit Thread	Description
Standard	220°F (+140°C)	Glass Filled Nylon®	2" NPTM	3/4" NPTM	General Purpose
High-Temp.	400°F (+205°C)	Ryton®	2" NPTM	3/4" NPTM	High Temperature
Food-Grade	220°F (+140°C)	316 Stainless Steel		3/4" NPTM	Food-Grade

Bin Wall Fitting Installation
USDA Approved for Sanitary Service

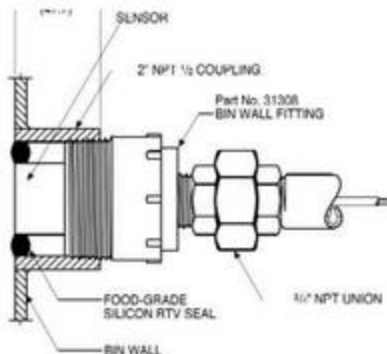

Installation Drawing

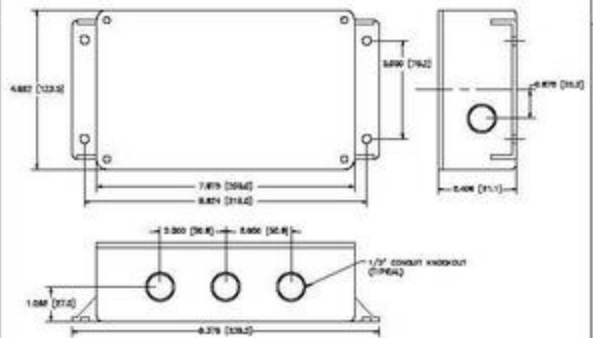

NOTE: DIMENSIONS IN PARENTHESES DENOTE MILLIMETERS

DEHAVAN

Process Instrumentation

TIME DELAY SETTINGS

Bin Level Control

Normally requires both time delays to insure that a turbulence upper level will not cause a false trip. Clockwise rotation of Beam Make and Beam Break increases time delay.

Plugged Chute Control

Applications will normally have a delay on Beam Break so that falling material will not trip the control relay prematurely.

Starvation Control

Applications require delay on Beam Make so that when product ceases to flow (starvation) the relay will not operate until some reasonable time period has elapsed. This prevents false signals due to temporary reduction in flow.

Object Detection Control

Such as vehicle washing equipment, require about 1/2 second delay on Beam Make and Beam Break to prevent false signals.

General Comments

Always use as much time delay as the application will permit. These time delay adjustments permit custom application of the SONAC®/220 system to your specific process needs.

SENSORS

SONAC® sensors are ruggedly constructed and hermetically sealed for dependable service and unlimited life under the most adverse operating conditions. SONAC® magnetostrictive transducers are provided in matched pairs. Thus, one acting as a transmitter operates efficiently only with its matched receiver. The matched sensors are identical in construction and act as either transmitter or receiver according to the way they are wired to the control unit.

CUSTOMER CONNECTIONS

SONAC/220

RELAY CONTACTS										SENSOR TRANS				SENSOR REC						
GND.	NEUT.	115 VAC	230VAC	NC	C	NO	NC	C	NO	BLACK	WHITE	SHIELD	SPARE	SPARE	+	-	LOW VOLT INPUT	SHIELD	WHITE	BLACK
1	2	3	4	5	6	7	8	9	10	11	12	13	14	15	16	17		18	19	20

ORDERING INFORMATION

SONAC®

220-

Process Mounting (Priced per Pair)
 S = Standard, Nylon 2 inch NPT
 220°F max.
 H = High Temp. Rylton 2 inch NPT
 400°F max.
 F = Food Grade, 304 Stainless Steel
 Sanitary Coupling
 R = Rear Mount 3/4 inch NPT

Sensors (Priced per Pair)

11L = 316 Stainless Steel Face w/50 ft. Cable
 14 = High Temp. 316 Stainless Steel Face
 w/15 ft. Cable per Sensor, 400° max.

Enclosure Options

S = Standard, NEMA 4x enclosure
 O = OEM, Electronic Assembly with
 Mounting Hardware (No Enclosure)
 C = Clear Cover NEMA 4X Enclosure
 T = Standard, NEMA 4x Enclosure external Self-Test
 option.
 D = Clear cover, NEMA 4x Enclosure external Self-Test
 option.

Model Sonac® 220 Ultrasonic Bulk Level Switch



NOTE: If multiple systems are used in the same vessel, please specify "Frequency Separation."

CSA Approved for Class II, Groups E, F, G;
 Divisions 1 Hazardous Locations

Recycling Equipment Corporation
 831 West 5th Street
 Lansdale, PA 19446
 Phone 267-218-7200 Extension 35
 Fax 267-218-7215

Buy Online at

www.RecyclingEquipment.com